

292/630 EM

Dimensions

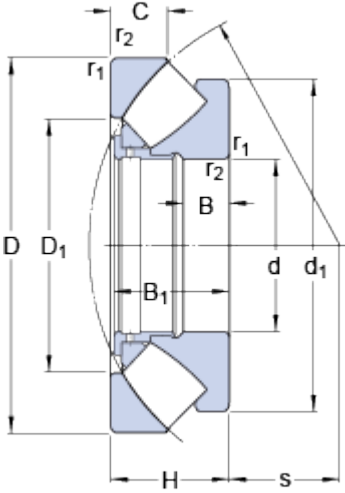

d	630	mm
D	850	mm
H	132	mm
d ₁	≈ 810	mm
D ₁	≈ 723	mm
B	50	mm
B ₁	127	mm
C	62	mm
s	338	mm
r _{1,2}	min. 6	mm

Abutment dimensions

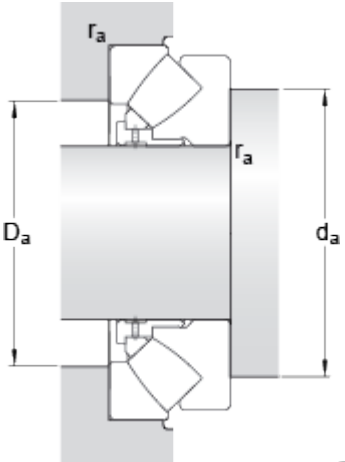

d _a	min. 740	mm
D _a	max. 780	mm
r _a	max. 5	mm

Calculation data

Basic dynamic load rating	C	4770	kN
Basic static load rating	C ₀	23600	kN
Fatigue load limit	P _u	1800	kN
Reference speed		400	r/min
Limiting speed		670	r/min
Minimum axial load factor	A	53	

Mass

Mass bearing		210	kg
--------------	--	-----	----